

BOOT

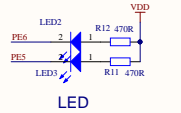

LED

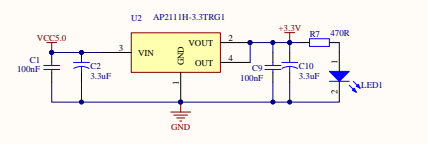

POWER

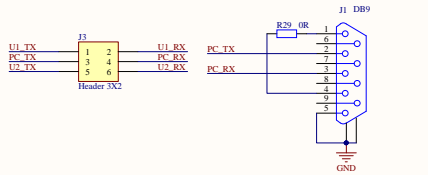

J1 DB9

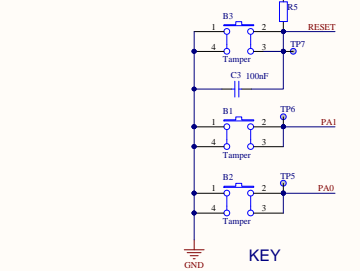
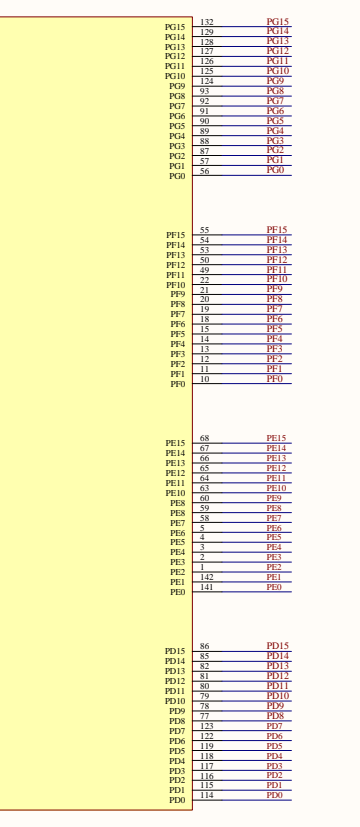
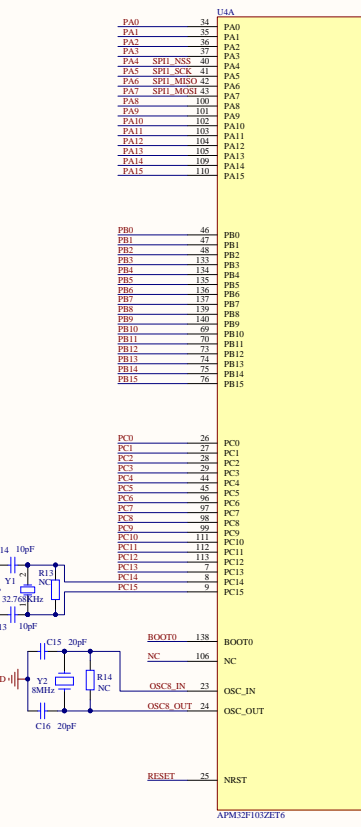

KEY

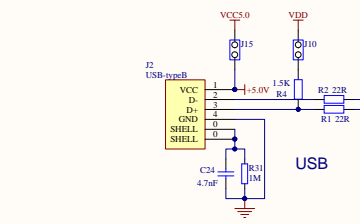

USB

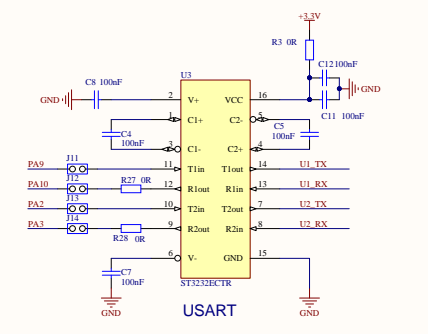

USART

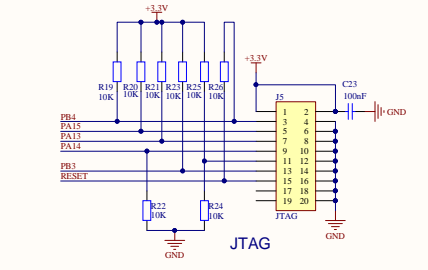

JTAG

